



THE i3
THE i3s

THE BMW i3 AND THE BMW i3s.



INNOVATION AND TECHNOLOGY.



18 Drivetrain and driving dynamics



22 Efficiency and range



24 Driver assistance and safety



25 Connectivity and infotainment



26 Loading comfort and mobility services



30 Materials and workmanship

INDIVIDUALITY AND DIVERSITY.



32 Exterior equipment



34 Interior equipment

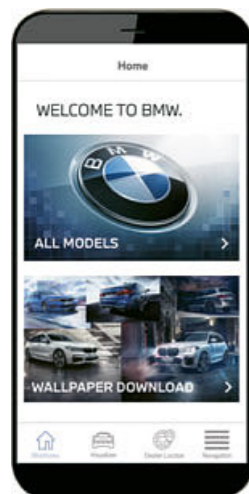

YOUR NEW SPEED DATING APP.

DOWNLOAD NOW THE BMW BROCHURES APP FROM YOUR APP STORE AND DISCOVER DRIVING PLEASURE!



38 Additional equipment



40 Born Electrics



42 Services and technical data



DRIVE TO
FEEL THE
ENERGY.

HOW ADRENALIN-CHARGED IS ELECTRIC DRIVING?

Full power, right from the start: The BMW eDrive electric drive provides maximum torque instantaneously. Just one push on the accelerator pedal is enough to accelerate you from 0 to 100 km/h in 7.3 [BMW i3s: 6.9] seconds, without gear changes or interruption. So when you take to the road in the BMW i3 or the BMW i3s you'll experience sustainability at its most dynamic and agile. The accelerator pedal also works as a brake: Taking your foot off the accelerator recovers the kinetic energy and brakes the vehicle. This innovation, called "One-pedal-feeling", allows you to experience the driving dynamics even more directly.



MY WATCH, MY PHONE, MY HOME ARE ALL SMART. SO HOW SMART IS THE BMW i3?

The smart way to make your life easier. The BMW i3 and the BMW i3s aim to make your daily life even easier through intelligent connectivity. For example, you can read the range of your vehicle on your smartwatch. You can precondition the car via smartphone, bringing the interior temperature to the desired level while the vehicle is being charged, without drawing on the battery. When you're on the road, your BMW i navigation system¹ knows the current range, the most efficient route and, of course, the charging stations available on the way. Everything at home prepared for your arrival? Don't worry, if it isn't, because with BMW ConnectedDrive*, you can control your Smart Home from your BMW i3 and your BMW i3s.

¹ Available as optional equipment.
* The availability of some equipment features and functions depends on engine variants or additional options.
The market and production availability may vary. You can find detailed information about terms, standard and optional equipment at www.bmw.com or from your BMW Partner.
Some ConnectedDrive Services may differ between countries. Please consult your local BMW partner for more information.







HOW CAN DRIVING PLEASURE AND SUSTAINABILITY GO TOGETHER?

Easily! With the fully electric BMW eDrive, you'll leave a lot of more powerful vehicles behind you at the traffic light – emitting zero pollutants as you do so. Enjoy the comfort of the exclusive interior, which is built using renewable or recycled raw materials. Outstanding design meets sustainable production. Sustainability principles are applied throughout from development to production and beyond. For example, energy from regenerative sources is used in the manufacturing process. Advancing sustainability and progress together – the BMW i3 and the BMW i3s.



I HAVE MY OWN PERSONALITY – DOES THE BMW i3?

The design of the BMW i3 and the BMW i3s really stands out from the crowd. It showcases individuality, while also impressively demonstrating how progress can be interpreted in a dynamic way. Its powerful lines and the black belt – running from the bonnet across the roof to the rear – create a sense of speed, even when the car is at a standstill. The passenger cell, made of carbon without B-pillars and the front and rear doors opening in opposite directions reflect the innovative character of the car and provide a unique sense of spaciousness. The BMW i3s shows its athletic personality even more distinctly: Design elements accentuating its width, such as the pronounced front and rear apron, radiate confidence, poise and performance. In the interior, you can choose from four different interior designs and create your own, personal atmosphere of comfort.





Temp: +24.7°C
0 READY
078.0 km
ECO PRO+
182 km

87.5 MHz 12:37
MediaRadio
87.5 MHz
Communications
Navigation
ConnectCar
MySetting
4 2017
308 km
0
No notifications

PREMIER
1 2 3 4 5 6 7 8
AUTO MAX AC
ECO PRO+
22.0

WHAT'S THE BEST WAY TO STAY AHEAD, WHEN IT COMES TO CHARGING?

Well, actually there are three: With the standard charging cable, you can charge your BMW i3 and your BMW i3s at any conventional household power socket. With the BMW Wallbox Essential¹, charging is even faster and more convenient. The BMW installation service offers comprehensive advice and conveniently takes care of all installation works for you. The BMW Wallbox Plus¹ can be integrated into your home internet network via LAN and controlled with the BMW iV app while its use can be managed with an access card. Naturally, the most sustainable charge uses electricity from your own solar power system. And if you want to charge while on the road, BMW Charging offers you the world's largest network of public charging stations. Your vehicle is automatically charged in the best possible time, so that you can continue your journey in the best way.

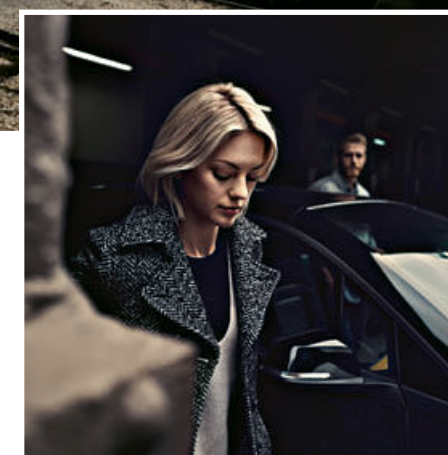
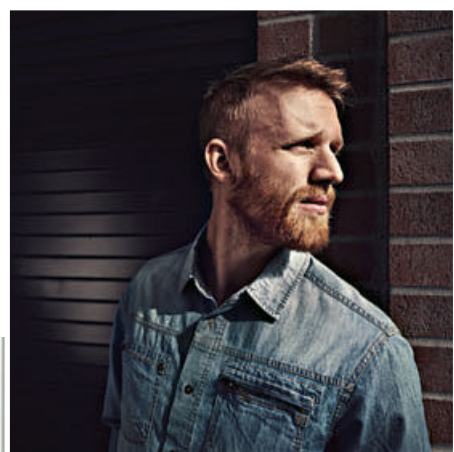

TO THE OFFICE.
TO FRIENDS.
TO THE GREAT
OUTDOORS. AND
BACK AGAIN.
IS THE BMW i3
FLEXIBLE ENOUGH
FOR MY LIFE?

Regardless of your destination, you'll get there with ease in the BMW i3 and the BMW i3s. Most people in the city don't travel more than 50 km a day, so you'll be all set with the BMW i3 and the BMW i3s, and the commute to the office and back will be no problem at all. With a range of up to 260 km² under common conditions you'll have plenty of leeway for paying friends in the country a spontaneous. You can even drive to the sea or the mountains for outdoor activities. BMW Charging offers you the world's largest network of public charging stations – simple, convenient and always there when you need it.

For further information on range, fuel consumption and CO₂ emissions, see the technical data or contact your BMW partner.

¹ Equipment available as an option from Original BMW Accessories.

² Range dependent on various factors. In particular: personal driving style, route characteristics, exterior temperature, heating/air conditioning, pre-conditioning.







ELECTRIFYING DYNAMICS, CHARGED WITH EXCITEMENT.

Everything about the BMW i3 and the BMW i3s is designed for electrifying driving dynamics and agility. It starts with the LifeDrive vehicle architecture, which is specifically designed for the demands of electric mobility, continues with the innovative BMW eDrive drive technology, and really gets going when it comes to precise, agile steering. The result is a unique driving experience that makes the dynamics of electric driving immediately perceptible in the BMW i3 and the BMW i3s.

DRIVING EFFICIENT DYNAMICS: BMW eDRIVE.

The **BMW eDrive** is a BMW original development. With a top power output of 125kW (170hp) and maximum torque of 250Nm in the BMW i3 and 135kW (184hp) and torque of 270Nm in the BMW i3s both models deliver a uniquely dynamic performance. But what does that mean in practice? Firstly, that maximum torque is available from the get-go. Once underway, both the BMW i3 and the BMW i3s put their power on the road almost instantaneously. A one-speed transmission does away with the need for gear changes and speeds up acceleration. The fact that you travel almost noiselessly and emit no exhaust fumes in the BMW i3 and the BMW i3s adds a new aspect to the sheer pleasure of driving a BMW.¹

DESIGNED FOR MAXIMUM EFFICIENCY AND DYNAMICS: THE DRIVE MODES.

The BMW i3 and the BMW i3s have a range of up to 260km² in the standard COMFORT mode and under everyday driving conditions. However, you can extend this range. Using Driving Experience Control, you can select one of the highly efficient **drive modes ECO PRO** or **ECO PRO+** to further increase your potential range.

135 kW (184 hp)

and an unladen weight (EU) of only 1,365 kg⁴ combine to make the BMW i3s³ excitingly dynamic to drive.

“WHAT ARE THE ADVANTAGES OF AN ELECTRIC MOTOR?”

6.9 s

to accelerate from 0 to 100km/h in the BMW i3s.⁵

14.0–14.6 kWh/100 km

Power consumption⁶ (in the BMW i3s approximately 3.77–3.93 euros per 100 km).⁷

BMW i3s SPORT SUSPENSION.

The **sport suspension** further increases the vehicle's dynamics and agility. The equipment includes tighter springs and dampers, along with a stabiliser on the front axle. Moreover, with the sport suspension the vehicle is lowered by ten millimetres.

BMW i3s SPORT STEERING.

The **sport steering** in the BMW i3s, which comes with a correspondingly adapted steering torque characteristic, delivers an even more athletic and tight steering experience. The vehicle can be guided with even greater pinpoint accuracy, adding to the driving pleasure especially on winding roads and in the city.

¹ For further information on range, fuel consumption and CO₂ emissions, see the technical data or contact your BMW partner.

² Range dependent on various factors. In particular: personal driving style, route characteristics, exterior temperature, heating/air conditioning, pre-conditioning.

³ BMW i3 top performance: 125 kW (170 hp).

⁴ EC unladen weight for the new BMW i3: 1345 kg. The EC unladen weight refers to a vehicle with standard equipment and does not include any optional extras. Unladen weight includes a driver weight of 75 kg. Optional equipment may affect the weight of the vehicle, the payload and the top speed if the selected equipment has an impact on the vehicle's aerodynamics.

⁵ BMW i3 acceleration: 7.3 s.

⁶ BMW i3 power consumption: 13.1 kWh/100 km.

⁷ With BMW Green Energy's exclusive offer powered by Naturstrom, 100 km cost approx. 3.77–3.93 euros (at 0.269 euros per kWh – electricity price depends on the provider). The cost calculation is based on combined consumption (in accordance with NEDC). For further information please contact your local BMW partner.

To usher in the era of electric mobility, it was necessary to entirely reinvent the automobile. One of the greatest challenges was to compensate for the weight of the lithium-ion high-voltage battery. To solve this problem, the vehicle architecture was divided into two individual entities: Both the suspension and drive components as well as the battery are located in the lower aluminium Drive module. This means the entire space of the life module can be flexibly utilised by the driver and passengers. Here we succeeded for the first time in designing a standard passenger cell produced from exceptionally light and high-strength carbon fibre. This not only lowers the weight and centre of gravity of the BMW i3 and the BMW i3s – but also boosts safety and agility.

“HOW DOES THE LIFE-DRIVE ARCHITECTURE IMPROVE THE CAR’S HANDLING?”

1,365 KG

is the weight of the BMW i3s in accordance with EC² directives, making it significantly lighter than comparable electric vehicles.

50%

lighter than steel, carbon is also exceptionally strong.

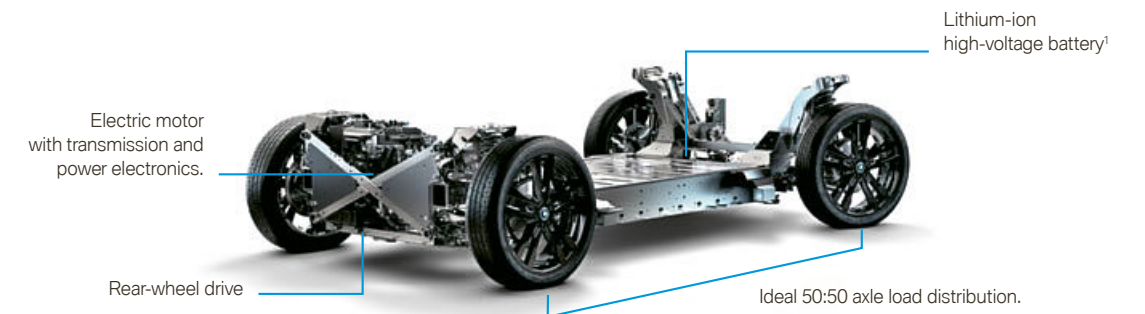

THE LIFE MODULE: SAFE LIVING SPACE.

The entire space of the **Life module** can be flexibly utilised. The driver and front passenger aren't separated from one another by a centre tunnel. There's no B-pillar between the side doors that swing open in opposite directions. The resulting generous loft atmosphere is unique for a car in this class. The spacious construction is made possible because the standard passenger cell is produced from high-strength carbon. This reduces the weight (EU) of the BMW i3 to 1,345kg and that of the BMW i3s to 1,365kg, providing both vehicles with unique agility while increasing their range.² At the same time, the robust carbon construction offers a high degree of safety, as demonstrated by numerous tests.

THE DRIVE MODULE: FOCUS ON SAFETY.

The **Drive module** consists of light aluminium and houses all drive-relevant components. Located in the rear, for example, are the electric motor and the transmission. The lithium-ion high-voltage battery is surrounded by a stable aluminium housing and is securely positioned in the undercarriage for the utmost in safety. Here the battery is optimally protected in case of an accident. Its position also provides the vehicle with a low centre of gravity that perfectly supports its agility. What's more, the battery is guaranteed for eight years or 100,000 km.¹

¹ The lithium-ion high-voltage battery is characterised by its long service life. However, should a defect occur in the high-voltage battery within eight years and the first 100,000 km, your BMW i Customer Care will grant you a free rectification. For details, please refer to the BMW i Battery Certificate.

² BMW i3 unladen weight (EU): 1345 kg. The EC unladen weight refers to a vehicle with standard equipment and does not include any optional extras. Unladen weight includes a driver weight of 75 kg. Optional equipment may affect the weight of the vehicle, the payload and the top speed if the selected equipment has an impact on the vehicle's aerodynamics.

OPTIMISED EFFICIENCY. INTELLIGENT ENERGY MANAGEMENT.

The combination of all the technologies in the BMW i3 and the BMW i3s serves as **intelligent energy management**, taking optimal advantage of the energy output and thereby ensuring the maximum range.

RELIABILITY GETS YOU AHEAD. THE DYNAMIC RANGE INDICATOR.

The **range display** in the BMW i3 and the BMW i3s informs you reliably about your range at all times. As simple as that sounds, it actually requires a complex program that can analyse a wide range of influential factors: Data on driving style, topography, temperature, driving mode, route planning as well as air conditioning and heating has to be evaluated in a matter of seconds. The result: a dynamic **range display** that's not only precise, but also analyses the influence of driving style and environmental factors.

DRIVING ON AIR: THE HEAT PUMP SYSTEM.

Electric vehicles have to be electrically heated since they have no combustion engine to produce excess heat for this purpose. The production of electricity, however, can reduce the vehicle's range. That's why we developed an innovative **heat-pump system** especially for winter weather. The optionally available heat pump works fully automatically and supports the efficiency of the interior heating. This reduces energy consumption with undiminished heating comfort and enables a higher range in cold weather.

THE RIGHT TEMPERATURE – FROM THE WORD GO.

The lithium-ion high-voltage battery in the BMW i3 and the BMW i3s also has what could be termed a comfort temperature: approximately 20 degrees Celsius. At this temperature capacity and range are at their highest. In markedly cold or hot weather we recommend using the BMW Connected App to reach the **optimum operating temperature** before you start driving. This has a pleasant side effect: The app also lets you pre-heat the interior. Especially in winter, pre-conditioning provides improved comfort and increased range.^{1,2,*}



ELECTRIC DRIVING PLEASURE. MAXIMUM EFFICIENCY.

In the BMW i3 and the BMW i3s, the BMW eDrive electrical drive concept developed by BMW combines maximum driving pleasure with the highest efficiency: The innovative electric motor translates the energy of the lithium-ion high-voltage battery into an exciting, dynamic driving experience. At the same time, intelligent energy management settings ensure that the best possible performance is available at any time, e.g. when energy is recovered as soon as you take your foot off the accelerator. The result: ideal range and driving pleasure that turns every trip into an experience.

¹ This feature is only available in conjunction with ConnectedDrive Services and a compatible smartphone. The range of functions depends on the apps installed on the smartphone.

² The active battery cooling is standard, the battery heating only in conjunction with the optional equipment seat heating for driver and front passenger.

* The availability of some equipment features and functions depends on engine variants or additional options. The market and production availability may vary.

You can find detailed information about terms, standard and optional equipment at www.bmw.com or from your BMW Partner.

Some ConnectedDrive Services may differ between countries. Please consult your local BMW partner for more information.



SAFETY CAN BE THIS COMFORTABLE.

Personal safety is still the highest priority in the BMW i3 and in the BMW i3s. This is achieved by measures such as the highly-rigid carbon construction of the passenger cell, designed for increased stiffness, and LED headlights with LED low beam and LED high beam or even Adaptive LED headlights¹ for ideal visibility. A wide range of innovative driver assistance systems in the BMW i3 and in the BMW i3s makes driving, and even parking, a particularly carefree and enjoyable experience.



The **Driving Assistant Plus**^{1,3,*} equipment produces a clear improvement in safety and comfort. It includes the Approach control warning and Person warning with light city braking function, Speed Limit Info*, Camera-based cruise control with Stop&Go function as well as the Traffic jam assistant.

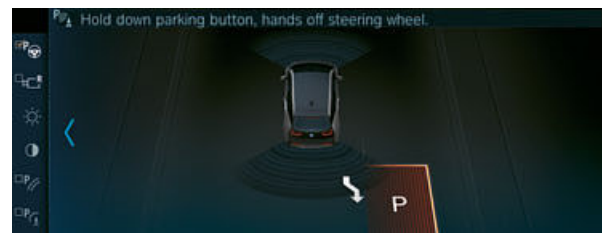

The **Park assistant package**^{1,2,4} really does make parking a breeze. The system combines the Parking assistant with **Park Distance Control (PDC)** and the Rear view camera to make your life much easier. If desired, the assistant can even manoeuvre into a space fully automatically.

i FOR INTELLIGENTLY CONNECTED.

Thanks to BMW Connected*, you can start your intelligent route planning from the comfort of your own home. You can share your live driving status with friends and business associates and keep an eye on all mobility related information via BMW Connected Onboard. You can even manage your smart home from inside the vehicle thanks to **BMW Connected**. Navigation system Professional¹ features a new user interface and can be relied on to get you from place to place. Not to mention on-street parking information^{1,*} which even helps you find a parking spot. Other features such as Real Time Traffic Information^{1,*} keep you up-to-date and make sure you always arrive stress-free. Remote Services^{1,*} let you control your vehicle conveniently from a distance, for example by viewing the charging status of your car quickly and easily on your smartphone.

BMW i CONNECTED DRIVE SERVICES FOR NAVIGATION.

BMW i ConnectedDrive Services for navigation^{1,*} offers all of the information that makes electric driving easier and more convenient. The dynamic range map and range assistant make up its core. The ECO ROUTE function shows the most efficient route and displays charging stations along the way.

BMW ConnectedDrive So connected, you're free.

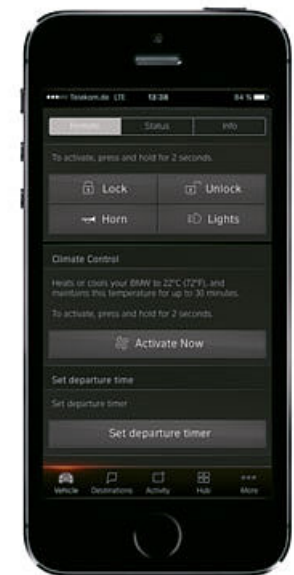

¹ Available as optional equipment.

² Only available for BMW i3.

³ Function may be limited in darkness, fog or bright glare.

⁴ The driver is responsible for constantly monitoring the automated parking procedure in accordance with local road laws.

* The availability of some equipment features and functions depends on engine variants or additional options. The market and production availability may vary.

You can find detailed information about terms, standard and optional equipment at www.bmw.com or from your BMW Partner.

For more information, please visit www.bmw.com/ConnectedDrive or contact your local BMW partner.

Some ConnectedDrive Services may differ between countries. Please consult your local BMW partner for more information.

FULL CHARGE OF FLEXIBILITY.

The BMW i3 and the BMW i3s offer the perfect playing field for those who want to enjoy their lives in a flexible and mobile way: Whether you're at home or on the road, you'll find opportunities to charge your BMW i3 and your BMW i3s quickly, easily and anywhere with BMW CHARGING. With the extended mobility services of BMW i and a constantly-growing infrastructure, you'll be even more flexible and able to fully enjoy the pleasure of driving – any time and any place.

CHARGE AT HOME.

Open all hours. Your own charging point at home. Electrifying driving pleasure starts with the charging process – at your own charging point at home. The **BMW Wallbox Essential²** turns charging into a sustainable experience. All BMW Wallboxes support quick charging, meaning that you can recharge your BMW i3 and your BMW i3s to 80% of their capacity in approximately three hours, depending on the power supply¹. The **BMW Wallbox Plus²** enables you to control access via a chip card while its load management ensures that the electricity available from the domestic connection is at all times efficiently used for charging the vehicle.

Naturally sustainable: green power. Emission-free driving can be made even more sustainable if you use emission-free electricity. Sign up with Naturstrom AG and your car will be charged only with electricity generated 100% from wind power and hydro power. This means, you will produce no emissions whatsoever when you drive in fully electric mode. In addition, you can use the innovative solar energy systems by SOLARWATT GmbH to charge your BMW i3 and your BMW i3s with home-produced solar energy.



BMW WALLBOX.

Charging the BMW i3 and the BMW i3s at home is made easy with three different BMW Wallbox models to choose from. With their three-phase alternating current, they feature a charging capacity of up to 11kW and can charge the lithium-ion high-voltage battery in the BMW i3 and the BMW i3s in approx. three hours from 0 to 80%. The BMW Wallbox models are easy to connect into the mains supply of a private home and, depending on the market, the BMW i installation service helps with the installation.

BMW WALLBOX PLUS.

The BMW Wallbox Plus² combines fast charging with the newest technologies and first-class comfort. The built-in chip card reader with lock function ensures reliable access.

BMW WALLBOX CONNECT.

The BMW Wallbox Connect² combines all technical possibilities of the new generation of BMW i charging products. WiFi functionality with accessible charging history enable a completely connected and comfortable operation.



¹ Dependent on local electricity infrastructure and the selected optional equipment.
² Equipment available as an option from Original BMW Accessories.

CHARGING ON THE GO.

Electric driving pleasure is on the increase: thanks to more and more charging points. There are lots of good reasons to get out and about in your BMW i3 and your BMW i3s – and just as many opportunities to charge the battery. Whether you're shopping or travelling to or from work, you'll find that the network is expanding rapidly. And thanks to intuitive controls, using it couldn't be easier. BMW CHARGING offers you access

to the CHARGE NOW mobility service, which merges different providers' charging points into one huge network. This makes it much simpler and quicker to locate charging points and charge your BMW i3 and your BMW i3s. All available charging points are displayed in the navigation system, on the smartphone via the BMW Connected App and ChargeNow App and on the website.*



BMW CHARGING CABLE.

The **charging cable** allows the vehicle's high-voltage battery to be recharged using any domestic power socket. When not in use, the five-metre* long cable can be tidily stowed away under the bonnet in the cable box so that it's always quickly at hand when on the move.



MOBILITY SERVICES.

Our world is changing. And so is our idea urban mobility. The joint mobility services of the BMW Group and Daimler AG perfectly match urban mobility needs. They are easy to use, intuitive, convenient and designed to meet individual

requirements. They all share one goal: to make life easier for our customers and help them enjoy their everyday life – no matter where their journey takes them.

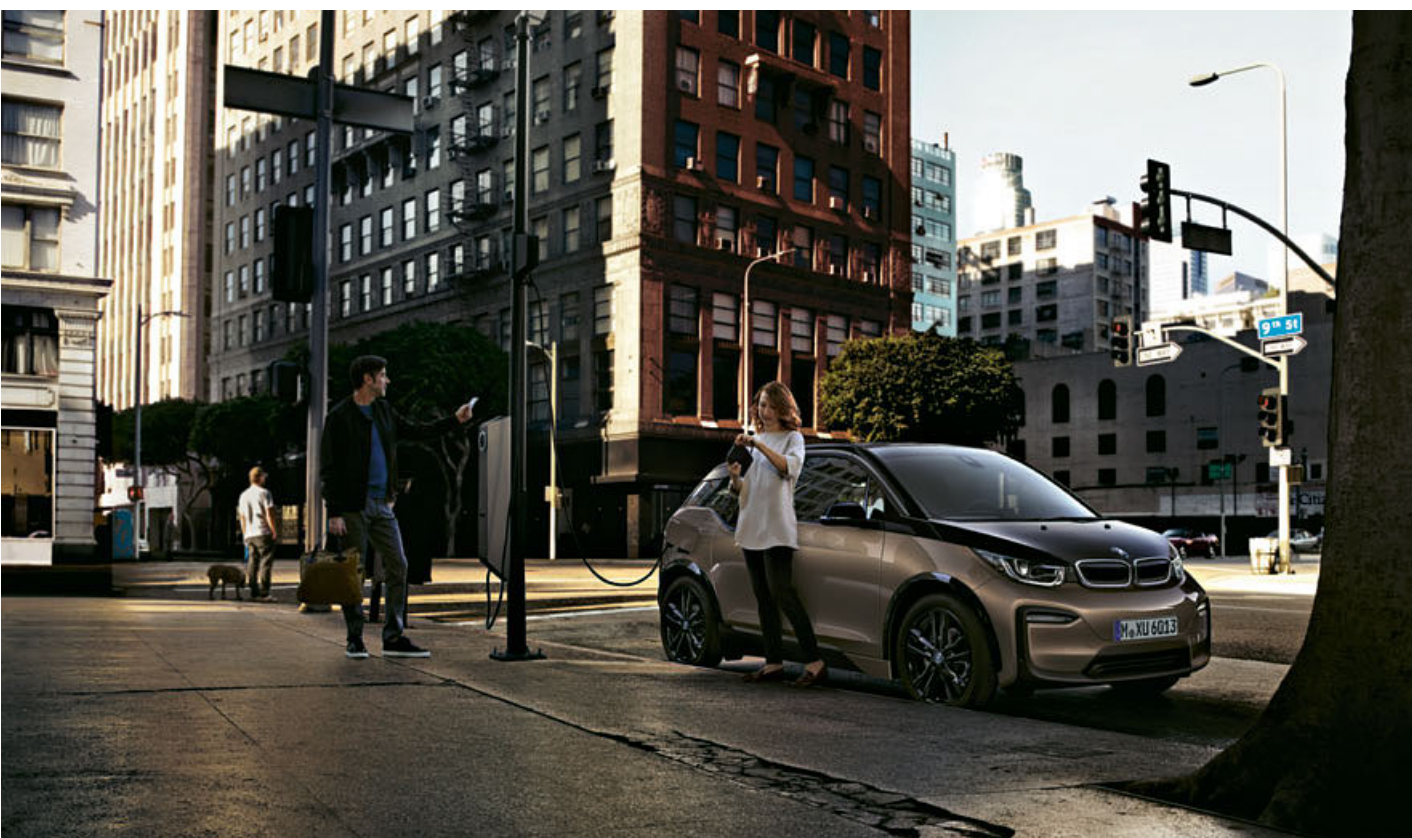

BMW i VENTURES.

BMW i Ventures invests in cutting-edge automotive technologies and innovative solutions focused on the needs of urban populations. It invests in high-growth companies with great potential when it comes to shaping the future of global mobility.

SHARENOW ✓

SHARE NOW is the flexible car sharing service of the mobility joint venture between the BMW Group and Daimler AG and combines the two car sharing services car2go and DriveNow.

PARKNOW ✓

PARK NOW is the innovative digital parking service from the mobility joint venture between the BMW Group and Daimler AG, which enables ticketless and cashless parking.

CHARGENOW ✓

BMW Charging enables drivers of electric vehicles to easily and conveniently find, use and pay for public charging stations locally and abroad.

* The availability of some equipment features and functions depends on engine variants or additional options. The market and production availability may vary. You can find detailed information about terms, standard and optional equipment at www.bmw.com or from your BMW Partner.

Some ConnectedDrive Services may differ between countries. Please consult your local BMW partner for more information.

01 **30 %** KENAF.

Through the extensive use of kenaf fibre, which is up to 30% lighter than conventional material, we have succeeded in replacing petroleum-based plastics and reducing the weight of the BMW i3 and the BMW i3s. This step is a tangible expression of the overall concept of the BMW i3 and the BMW i3s. The extremely light material is produced from a mallow plant that converts an exceptional amount of CO₂ into oxygen during its growth.

02 **34 %** PET.

Don't recycle, upcycle – the sustainable fabric used in the interior of the BMW i3 and the BMW i3s is made from almost 100% recycled polyester, 34% of which is sourced from PET bottles. PET granules undergo a process of melt extrusion and pigments are added to produce first the fibre, then the yarn and finally the fabric. The seat covers produced in this way aren't just pleasant to the touch and look appealing, they are also highly durable.



03 **90 %** EUCALYPTUS WOOD.

Eucalyptus is naturally resistant to moisture and therefore requires about 90% less surface processing than conventional wood. Because it's processed without chemicals, it retains its silky texture and natural pore structure. With a height of 60m, the rapidly growing eucalyptus tree is ideally suited for sustainable wood production. All wood used is grown on FSC-certified plantations that insure forest sustainability.

SUSTAINABLE MATERIALS FOR A UNIQUE AND PLEASANT ATMOSPHERE.

The materials used in the BMW i3 and the BMW i3s aren't only an experience for the senses. They also express a sustainable lifestyle, since they're largely made of recycled or renewable raw materials, such as eucalyptus. Even the processed carbon is manufactured in an environmentally friendly way through the use of regenerative energies. Sustainability is a distinct experience in the BMW i3 and the BMW i3s, threading its way through the entire production process.



DEVELOPMENT.

The entire vehicle concept was developed from the ground up with electric mobility in mind. By reducing air resistance, the vehicle's innovative aerodynamic design also reduces energy consumption. The use of renewable and recycled materials instead of conventional synthetic ones helps to protect the environment.

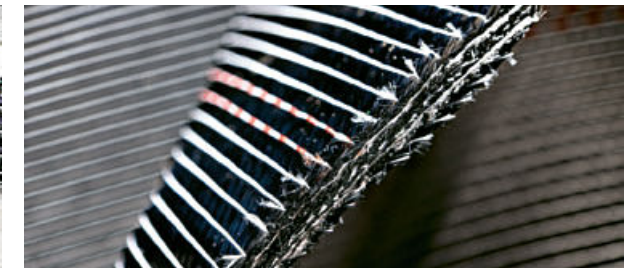

RECYCLING.

The BMW i3 and the BMW i3s are up to 95% recyclable. The battery modules can, for example, be reused as solar energy accumulators. The excess carbon fibre is partially recycled for use in the production process.



PRODUCTION.

The carbon fibres are produced completely with hydroelectric energy. In Leipzig, we manufacture the BMW i3 and the BMW i3s using only electricity generated from wind power. The energy needed for their production is half of that required for other BMW models, which is low as it is.



USE.

No emissions are produced while driving. This reduces air pollution in cities. The BMW i3 and the BMW i3s are practically noiseless and produce no fumes. By fuelling with "green electricity" or producing your own power using solar cells, you can travel thoroughly emission-free. ECO PRO mode increases range and reduces power consumption.

INSPIRATION ACROSS THE BOARD.

The six **exterior colours** of the BMW i3 and the BMW i3s all have one thing in common – their power of expression. The colour spectrum of the two non-metallic as well as the four metallic paints stretches from subdued to expressive and can be freely combined with every interior design package. Depending on the choice of exterior colour or interior equipment, the highlight areas on the side skirts and double kidney grille come in either BMW i Blue or Frozen Grey metallic. The contrast of Black Belt and the exterior paint provides the vehicle with an extremely innovative look in two colours that emphasise its dynamic qualities.

The **light alloy wheels** in the BMW i3 and the BMW i3s are designed to be especially narrow, in order to reduce air and roll resistance as much as possible. The large tyre diameter of 19" and 20" reinforces the sporty and agile character of the vehicle and contributes to the maximisation of tread contact. Some rims are enclosed, in order to avoid unnecessary air turbulence and increase the vehicle's range. To create a sporty and airy look, the available light alloy wheels have been designed in visibly distinctive high-gloss black and gloss-lathed sections. Four of them are exclusively available for the BMW i3.



Metallic C1W IMPERIAL BLUE with highlight Frozen Grey metallic¹



Metallic C3P JUCARO BEIGE with highlight Frozen Grey metallic¹



Metallic C32 MELBOURNE RED with highlight Frozen Grey metallic¹



Metallic C2V MINERAL GREY with highlight BMW i Blue¹

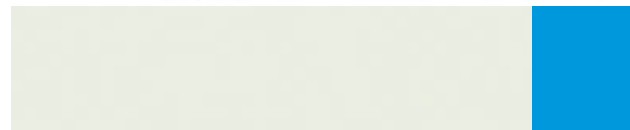

Metallic B85 CAPPARIS WHITE with highlight BMW i Blue*

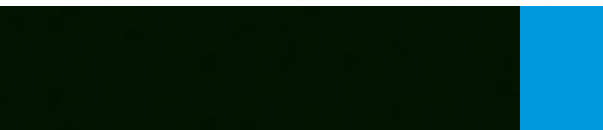

Metallic C2W FLUID BLACK with highlight BMW i Blue¹

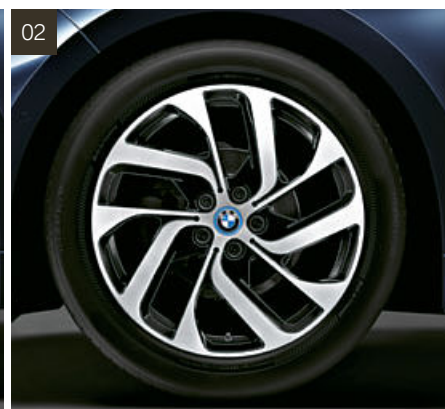
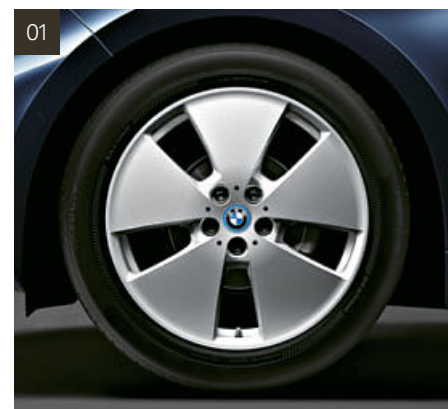

[01] 19" BMW i light alloy wheels Star-spoke style 427, BMW EfficientDynamics^{1,*} [02] 19" BMW i light alloy wheels turbine styling 428 with mixed tyres^{1,*} [03] 19" BMW i light alloy wheels turbine styling 429 with mixed tyres*

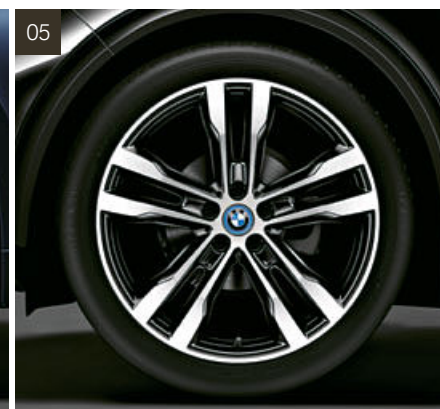
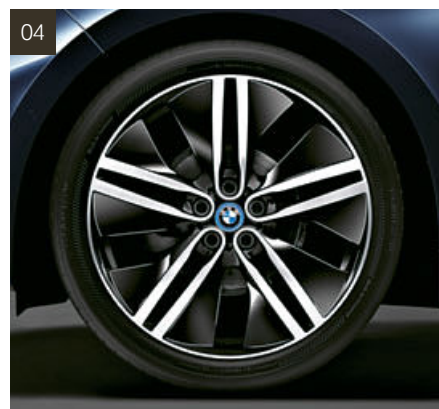

[04] 20" BMW i light alloy wheels Double-spoke style 430 with mixed tyres^{1,*} [05] 20" light alloy wheels Double-spoke style 431 with mixed tyres* [06] 20" light alloy wheels Double-spoke style 431 Jet Black with mixed tyres^{1,*}

[Colour samples] These colour samples are intended as an initial guide to the colours and materials available for your BMW. However, experience has shown that, in some cases, display representations of paint, upholstery and interior trim colours can differ from the actual items depending on the monitor/device and screen resolution. We therefore recommend that you consult your BMW partner on your preferred colour choices. They will be happy to show you samples and assist you with any special requests.

* The availability of some equipment features and functions depends on engine variants or additional options. The market and production availability may vary. You can find detailed information about terms, standard and optional equipment at www.bmw.com or from your BMW Partner.

¹ Available as optional equipment.

MINIMALIST AND HIGH QUALITY: THE ATELIER INTERIOR.

The interior design Atelier is characterised by the gentle contrast of dark interior trim, grey cloth combination and individual blue accents. The trim in the instrument panel and the door areas is made from the mallow plant kenaf. This innovative material is a particularly distinctive design feature of the basic equipment option. Not only is it a lightweight material, but its subtly blended surface has the natural look of felt. Just like the colour in the BMW logo, the blue of the seat side bolsters and

the fine seam of the leather steering wheel symbolise the innovative character of all BMW models. The gently curved design of the instrument panel with its matt grey surface accentuates the minimalist character of the basic equipment in the BMW i3 and the BMW i3s. As in all BMW models, it combines form with function. In addition to the sensuous aesthetic it provides, it also serves as a storage area and glove compartment lid.



[01] BMW i interior design Atelier: Leather steering wheel with BMW i Blue accent, Black instrument panel. **[02]** Interior trim finisher Andesite Silver matt. **[03]** Seats with cloth combination 'Neutronic' Aragats Grey and BMW i Blue contrast stitching.

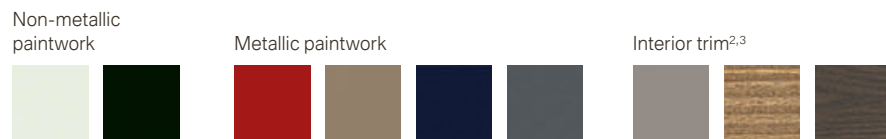

Six expressive metallic and non-metallic exterior colours for the BMW i3 and the BMW i3s are precisely matched to the interior design. Further information can be found in the "Equipment" section under "Exterior".

¹ Available as optional equipment.
² Certified according to Forest Stewardship Council® (FSC®) standards for responsible forest management.
³ Fine-wood trim Eucalyptus matt and fine-wood trim Oak dark matt optionally available.

Images show standard and optional equipment as well as accessories.

ELEGANT AND LIGHT: THE INTERIOR DESIGN LOFT.

The interior design Loft is characterised by a purist aesthetic and high quality at the same time thanks to its seats with cloth/Sensatec combination 'Electronic' Carum Spice Grey with Brown accent. The light grey tone of the seats returns in sections of the dashboard and the side panels. At the same time, the light grey enhances the bright and reduced loft character of the BMW i3 and the BMW i3s, while the interior trim finishers in Electronic Brown set modern accents and

emphasise the slim appearance and the lightweight aspect of the newly designed interior equipment. The modern cloth combination for the seats in both the front and rear is manufactured from recycled synthetic material, similar to that used in high-quality functional wear. This same material provides optimum comfort by means of its temperature-regulating properties.



[01] BMW i interior design Loft: Leather steering wheel with BMW i Blue accent, Carum Spice Grey instrument panel. **[02]** Seats with cloth/Sensatec combination 'Electronic' Carum Spice Grey with BMW i Blue accent. **[03]** Interior trim finishers in Electronic Brown.



Six expressive metallic and non-metallic exterior colours for the BMW i3 and the BMW i3s are precisely matched to the interior design. Further information can be found in the "Equipment" section under "Exterior".

The availability of some equipment features and functions depends on engine variants or additional options. The market and production availability may vary. You can find detailed information about terms, standard and optional equipment at www.bmw.com or from your BMW Partner.

INVITING AND NATURAL: THE LODGE INTERIOR.

The Lodge interior design embodies the new and contemporary premium concept of the BMW i like no other design package. Its highly aesthetic combination of matt wood, soft leather and soft wool is essentially without equal in the automotive world. With its modern authenticity and sensuousness, it is characteristic of the BMW i concept of sustainability. The eucalyptus and oak wood are obtained only from certified and environmentally-friendly lumber companies. The wood is neither bleached, painted nor varnished and thus retains

its natural surface colour and texture. The wool cloth offers all the comfort of natural fibre, which is why manufacturers of luxury wear have used it for a long time. It cools in the summer and warms in the winter. In addition to being natural and sustainable, the material is also highly functional. Because the more comfortable the temperature, the less the driver needs the seat heating or air conditioning. By saving energy, this provides the BMW i3 and the BMW i3s with that much more range.

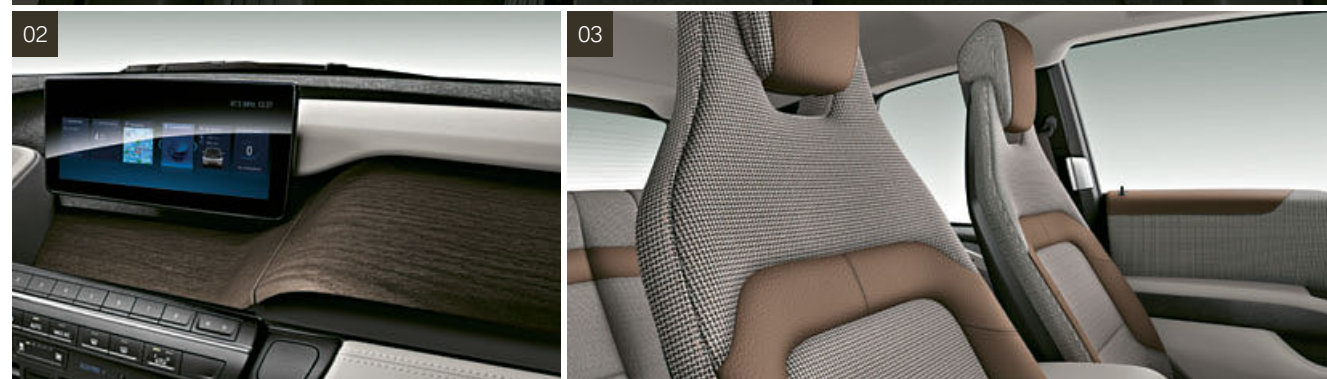

[01] BMW i interior design Lodge¹: Leather steering wheel with Satin Silver accent, instrument panel in Carum Spice Grey soft nappa leather. **[02]** Fine-wood interior trim finisher dark Oak, matt.^{1,2} **[03]** Seats made of climate-regulating wool cloth and 'Solaric' Brown leather.



Six expressive metallic and non-metallic exterior colours for the BMW i3 and the BMW i3s are precisely matched to the interior design. Further information can be found in the "Equipment" section under "Exterior".

¹ Available as optional equipment.
² Certified according to Forest Stewardship Council® (FSC®) standards for responsible forest management.
³ Fine-wood trim Eucalyptus matt, alternatively available fine-wood trim Oak dark matt.

Images show standard and optional equipment as well as accessories.

LUXURIOUS AND EXCLUSIVE: THE SUITE INTERIOR.

The Suite interior design characterises the generous use of leather in a warm dark brown tone that goes particularly well with the seats in leather 'Vernasca' in Dark Truffle. The instrument panel is covered with leather 'Vernasca' in Dark Truffle. Here, the targeted use of high-quality leather creates a stylish contrast to the contoured wooden elements made of oak dark matt. On the door panels, it harmonises with the individual fabric elements and with the base support system made from the mallow plant kenaf, to create a fascinating and varied overall

picture full. Despite the vehicle's luxurious character, the BMW i designers only integrate the soft leather surfaces where the driver can feel them and therefore needs them, such as on the armrests. Thus an individual variation combining fabric, leather and kenaf was introduced for the Suite equipment option. This combination forms a band that flows through the interior in the door areas, which, in turn, lends the interior of the BMW i3 and the BMW i3s its typical light and contemporary look, retaining full exclusivity.

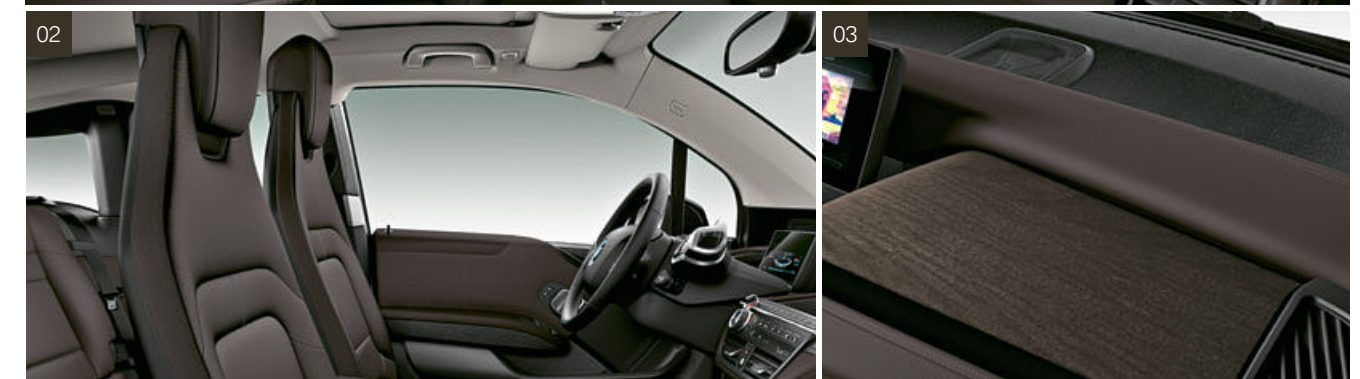

[01] BMW i interior design Suite¹: Leather steering wheel with Satin Silver accent, instrument panel in leather 'Vernasca' in Dark Truffle. **[02]** Seats in leather 'Vernasca' in Dark Truffle. **[03]** Fine-wood interior trim finisher in dark Oak, matt.²



Six expressive metallic and non-metallic exterior colours for the BMW i3 and the BMW i3s are precisely matched to the interior design. Further information can be found in the "Equipment" section under "Exterior".

The availability of some equipment features and functions depends on engine variants or additional options. The market and production availability may vary. You can find detailed information about terms, standard and optional equipment at www.bmw.com or from your BMW Partner.

ADDITIONAL EQUIPMENT.

■ Standard equipment □ Optional equipment

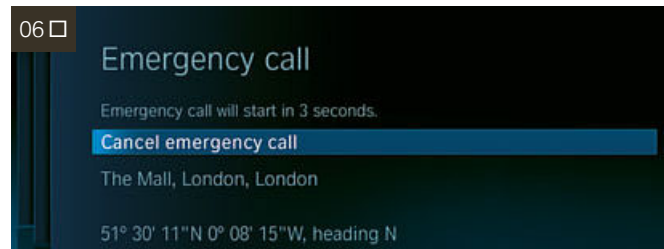

[01] The electrical glass roof provides the pleasant feeling of a generously proportioned, airy interior. The integrated wind deflector guarantees a high level of acoustic comfort. **[02]** The Comfort access system allows passengers to enter the car via the front doors and open the tailgate without having to actively use the key. **[03]** With the Seat heating for driver and front passenger the seat and backrest surfaces can be heated. **[04]** The HiFi loudspeaker system Harman Kardon with an external 360 watt amplifier consists of twelve speakers including two central subwoofers. **[05]** The

Navigation system Professional* is integrated to yield the optimum results and is easily operated using voice control or the iDrive Touch Controller. **[06]** Intelligent Emergency Call* automatically establishes a connection with the nearest rescue coordination centre through the BMW call centre whenever needed – without the use of a mobile phone. **[07]** Automatic air conditioning* includes Automatic Air Recirculation (AAR) with an active carbon filter, as well as fogging and solar sensors.

¹ Supports inductive charging for Qi-compatible mobile phones. Special charging cases are available from Original BMW Accessories for selected smartphones that do not support the Qi standard for inductive charging.

* The availability of some equipment features and functions depends on engine variants or additional options. The market and production availability may vary. You can find detailed information about terms, standard and optional equipment at www.bmw.com or from your BMW Partner.



[08] The sports package* underlines the dynamics of the BMW i3. It comprises 20" light-alloy wheels with double spoke style in bicolor or optionally jet black with mixed tyres, a sports suspension with vehicle lowering by 10mm, wide wheel arch trims and aeroflap sills on the sides, each in glossy black. **[09]** The seat belts for all four seats appear in BMW i Blue. They provide the same functionality as the standard three-point seat belts. **[10]** The foldable front armrest* includes an integrated storage compartment that offers additional



storage space for items such as a mobile telephone. **[11]** Telephony with wireless charging¹* offers a comprehensive telephony package with Bluetooth connectivity and the technical capacity for a WiFi hotspot. **[12]** Multifunction for steering wheel* can be used to operate the telephone, voice control and audio functions, as well as the Manual Speed Limiter. **[13]** The Storage compartment package* includes many practical storage possibilities, as well as additional 12V power sockets in the vehicle.

EVERY MOMENTOUS CHANGE IS DRIVEN BY PIONEERS.

Ever since the birth of BMW i in 2013, pioneers of electric driving around the world have worked to make their shared vision of a new era of mobility real. On social media they share their inspiring stories and

tell us about everyday experiences and electrifying moments with their BMW i3 and their BMW i3s. [#bornelectric](#)

TOM.

BORN ELECTRIC IN JUNE 2009.

[#instagram.com/tom.moloughney/](#)



“BE THE BEGINNING.”

I was lucky to be part of the BMW pilot programme for electric cars right from the start back in 2009. Electric driving changed my life. Being part of this pioneering spirit was always a huge privilege. And I could barely wait to share it with others. Just four or five vehicles and a dozen people showed up when I organised the first electric car get-together in front of my restaurant in New Jersey. I remember the enthusiasm like it was yesterday! Our little community has now

grown to three or four dozen electric cars and a few hundred people. And they say: “Drive my car, check out the interior, it’s awesome, you should do the same!” It’s an amazing sight to behold: My neighbour, my brother-in-law, the lady from the coffee shop downtown – they all drive electric cars and love it! There’s absolutely no doubt about it, the big switch to electric driving is happening and it’s unstoppable. It’s a movement and it’s happening right now.

KATHRYN.

BORN ELECTRIC IN SEPTEMBER 2014.

[#instagram.com/kbakken/](#)

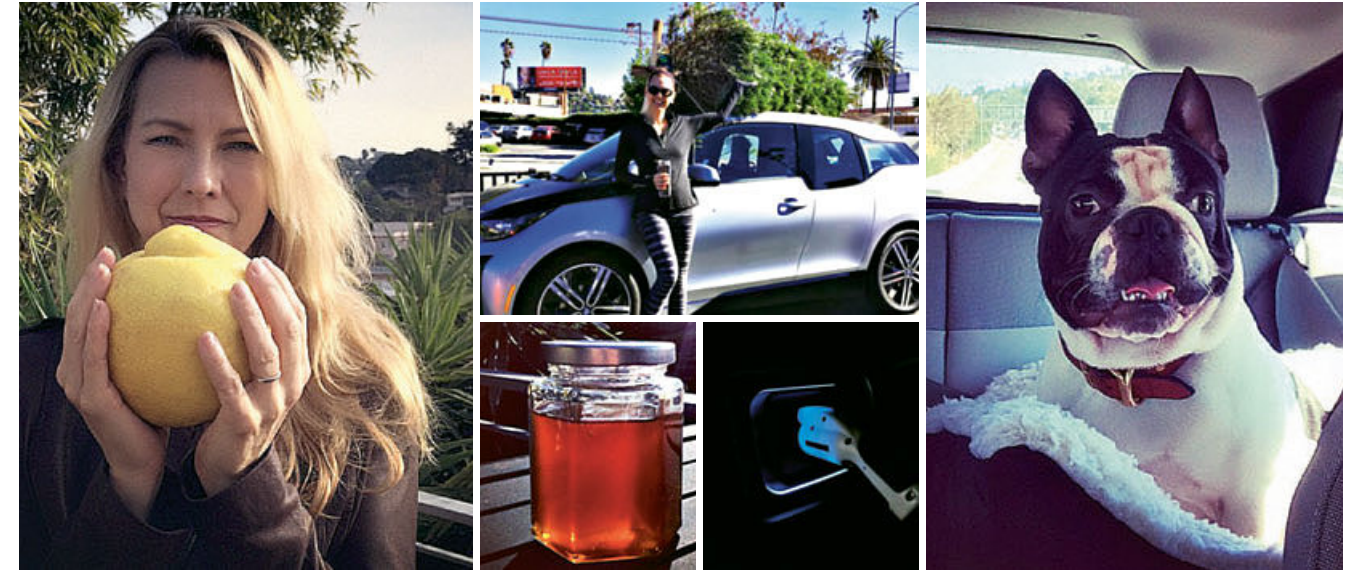

“MY LITTLE ELECTRONAUT.”

My weakness for gadgets means that I’m always open to new things, which is why I fell in love with electric cars from the word go. I was immediately impressed by the environmental aspect and futuristic design. Electric cars are all the rage – and it looks like the dream of an electric car is finally coming true. If you ask me, the future belongs to the electric car and not the petrol engine. When travelling in the

BMW i3, the tranquil, calm atmosphere in the car causes my stress level to ease. I enjoy the feeling of sitting in this car with its chic interior and coolly steering it through the streets. And yes, it does actually happen that people stop in their tracks when I drive by and shout over: “Hey, cool car.”

STEVE.

BORN ELECTRIC IN MARCH 2015.



“THE JOURNEY IS THE DESTINATION.”

My family and I love nothing more than going on extended road trips. The BMW i3 makes it possible to head off on these trips to faraway destinations for several days at a time without a care in the world. It offers us an easygoing lifestyle and expands our horizons, literally. Not only does it guide us to remote locations, but it’s also turning us into

true explorers. We have two kids, ages five and eight, and we want to show them the innumerable natural wonders here in our little corner of the world. The BMW i3 gives us that freedom. A trip is about much more than just the physical destination. In fact, it’s about all those little memories on the path to get there.

BMW i – CLOSER TO OUR CUSTOMERS IN MANY DIFFERENT WAYS.

BMW i offers you a wealth of possibilities to learn about our vehicles, consult with an expert, schedule a test drive, or even buy a BMW i – anytime and through many different channels. Whether it's online, by phone, from a mobile sales adviser or at the dealership, you can always be sure of personal service that meets your every wish.



Please visit www.bmw.com to find your local BMW partner.

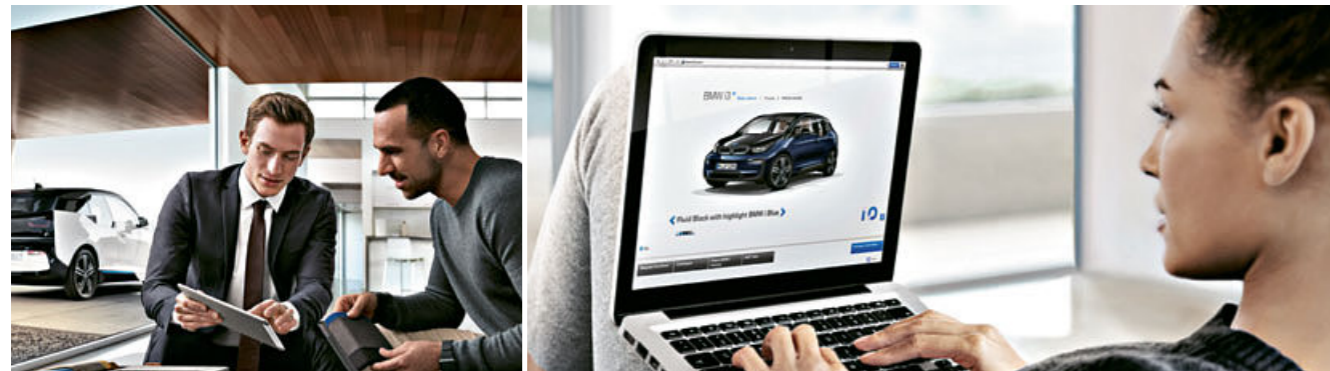

The BMW i Mobile Sales Advisor. BMW i has a mobile and flexible sales service. If you are unable to visit us, a member of our team of BMW i experts and sales advisors will be happy to come to you. They can also come by and let you take a test drive.

BMW FINANCIAL SERVICES.

BMW Financial Services offers bespoke financial service plans for your BMW i3 and your BMW i3s.

BMW Finance and BMW Leasing. BMW Finance offers customised programs to support you on the way to your very own BMW i car and forms the basis for all other insurance and mobility products provided by BMW Financial Services. With standard financing, you keep your liquidity while benefiting from a fixed interest rate over the entire term. Once this has ended the vehicle is yours. The flexible leasing options from BMW Financial Services are all simple, convenient and uncomplicated – to make your dream of driving pleasure in the BMW i3 and the BMW i3s a reality. BMW Leasing gives you the kind of financial flexibility you're looking for. Whether you drive your BMW i3 and your BMW i3s purely for business or mainly for pleasure.

Car insurance. Electrifying driving pleasure is a wholly new experience. You'll love how this makes you feel. Our bespoke insurance products will also give you a feeling of complete security. Comprehensive third-party cover, a flexible choice of excess level and professional repairs in a BMW i authorised garage in the event of damage – all these form the basis of our insurance solutions. To make sure you are fully prepared when you break all types of new ground with your BMW i3 and your BMW i3s.

THE BMW i3 AND THE BMW i3s.

Technical data		BMW i3	BMW i3s
Weight			
Unladen weight EU ¹	kg	1345	1365
Max. permissible weight	kg	1710	1730
Permitted load	kg	440	440
Synchronous electric motor			
Peak output/engine speed	kW (hp)/rpm	125 (170)/4800	135 (184)/7000
Max. output/engine speed	kW (hp)/rpm	75 (102)/4800	75 (102)/4800
Max. torque	Nm	250	270
Power transmission			
Type of drive		Rear-wheel	Rear-wheel
Standard transmission		1-speed automatic	1-speed automatic
Performance			
Top speed	km/h	150 ²	160 ²
Acceleration 0–60 km/h	s	3.8	3.7
Acceleration 0–100 km/h	s	7.3	6.9
Energy consumption			
Combined ³	kWh/100 km	13.1	14.0–14.6
Lithium-ion high-voltage battery⁴			
Battery type/gross battery capacity	in kWh	Li-ion/42.2	Li-ion/42.2
Range			
Electric range ⁵	km	359	345–330
Practical electric range (additional, voluntary information) ⁵	km	up to 260	up to 260
Charging times			
Charging time (DC rapid charging) ⁶	h	approx. 00:45	approx. 00:45
Charging time (AC rapid charging with BMW Wallbox ^{6,7})	h	approx. 03:00	approx. 03:00
Charging time (AC with standard charging cable at a conventional power socket) ⁶	h	approx. 15:00	approx. 15:00
Wheels/tyres			
Tyre dimensions		155/70 R19 84 Q	175/55 R20 89 T XL 195/50 R20 93 T XL
Wheel size		5 J x 19	5.5 J x 20 6 J x 20
Material		Light alloy	Light alloy

Dimensions of the BMW i3. Figures in [] are for the BMW i3s.

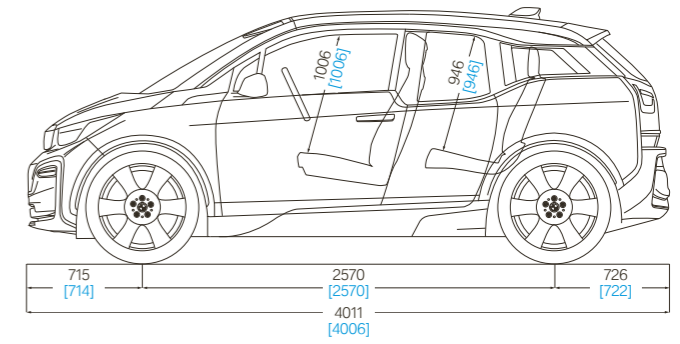
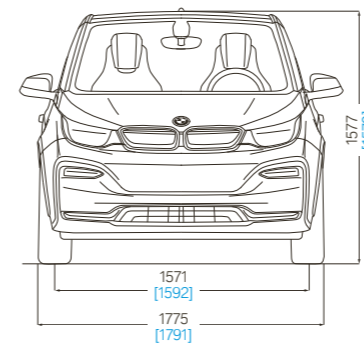

All dimensions in the technical drawings are given in millimetres. Luggage compartment volume 260–1,100 litres. The height of the BMW i3 with roof fin is 1598 mm. The height of the BMW i3s with roof fin is 1590 mm.

¹ The figures quoted are based on a driver weight of 75 kg. Unladen weight applies to vehicles with standard equipment. Optional equipment may affect the weight of the vehicle, the payload and the top speed if the selected equipment has an impact on the vehicle's aerodynamics.
² Electronically limited.
³ The data for fuel consumption, CO₂ emissions and energy consumption are determined in accordance with the measurements processes as defined by European Regulation (EU) 2007/715 in the applicable version. Data refer to a vehicle with base-level equipment in Germany, and the ranges account for differences according to the selected wheel and tyre size and the optional equipment and may change during the configuration process. Figures have been determined on the basis of the new WLTP test cycle and have been converted back into NEDC figures for comparability. [For these vehicles, values other than those specified here may apply for the assessment of taxes and other vehicle-related charges that are (also) based on CO₂ emissions.]
⁴ The lithium-ion high-voltage battery is characterised by its long service life. However, should a defect occur in the high-voltage battery within eight years and the first 100,000 km, you will be granted a free rectification. For details, please refer to the BMW i Battery Certificate.
⁵ Range dependent on various factors. In particular: personal driving style, route characteristics, exterior temperature, heating/air conditioning, pre-conditioning.
⁶ Dependent on the local electricity infrastructure. Charging time corresponds to an 80% charge of maximum capacity.
⁷ 11 kW 16 A 3 phase.

Since 1 September 2017, certain new vehicles are tested according to the Worldwide Harmonized Light Vehicles Test Procedure (WLTP) before type approval is granted – The WLTP provides a more realistic way of measuring fuel consumption, range and CO₂ emissions. As of 1 September 2018, the WLTP will replace the New European Driving Cycle (NEDC). Due to the more realistic testing conditions, the fuel consumption and CO₂ emissions are, in many cases, higher and the range lower than when measured according to the NEDC. Currently, it is still mandatory to communicate figures based on the NEDC. For new vehicles with WLTP-based type approval, NEDC figures are derived from their WLTP figures. WLTP-based figures may, until their use becomes mandatory, be given in addition on a voluntary basis.



YOUR NEW SPEED DATING APP.

DOWNLOAD NOW THE BMW BROCHURES APP FROM YOUR APP STORE AND DISCOVER DRIVING PLEASURE!

The BMW i3:

BMW eDrive synchronous electric motor, 125kW (170 hp), Sport package, 20" light alloy wheels Double-spoke style 431 Jet Black with mixed tyres, exterior colour in Jucaro Beige with Frozen Grey metallic highlight, seats in cloth/Sensatec combination Electronic Carum Spice Grey with Brown accent, BMW i interior design Loft with interior trim finishers in Electronic Brown.

The BMW i3s:

BMW eDrive synchronous electric motor, 135 kW (184 hp), 20" light alloy wheels Double-spoke style 431 with mixed tyres, exterior colour in Fluid Black with BMW i Blue highlight, seats in leather 'Vernasca' in Dark Truffle, BMW i interior design Suite with fine-wood trim Oak dark matt.

The models illustrated in this medium show the equipment and configuration options (standard and optional) for vehicles produced by BMW AG for the German market. Alterations in standard and optional equipment and the configurations available for the different models may occur after 11/12/2019, the editorial deadline for this medium, or according to the specific requirements of other markets. Your local BMW Partner is available to provide further details. Subject to change in design and equipment. Of course, each vehicle is designed for economical recycling after its long-running life. You can find more information regarding your end-of-life vehicle on our website www.bmw.de/recycling. © BMW AG, Munich, Germany. Not to be reproduced wholly or in part without prior written permission of BMW AG, Munich.